

Article number: 01010771  
 Description: Retaining ring A 62 DIN 471  
 Stainless 411  
 Note: Fitted with ZGA pilers

## Measures

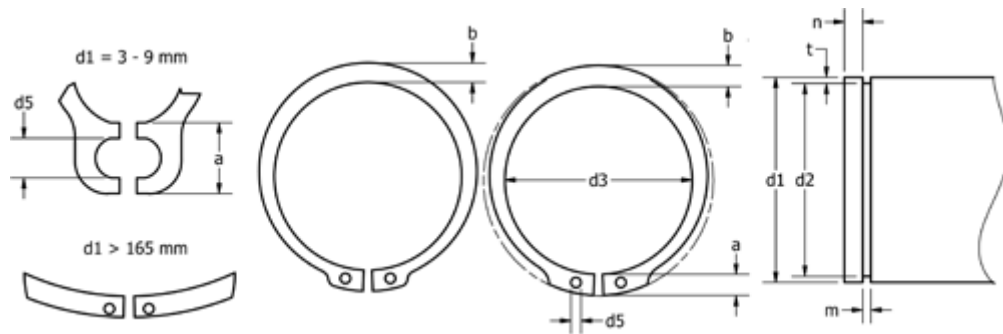

a max	= 7.5	FN kN	= 47.5	s	= 2.00
AN mm <sup>2</sup>	= 285.0	FRg kN	= 11.40	t	= 1.50
b	= 6.0	FR kN	= 69.30	tol	= -0.30
d1	= 62	g	= 2.5	tol	= -0.07
d2	= 59.0	K kN-mm	= 126.00	tol	= +0,46-1,10
d3	= 57.8	m min	= 2.15	Tong	= ZGA-3
d5 min	= 2.5	n abl x 1000	= 7.0	Weight kg/1000	= 14.300
Description	= A62	Nominal drive	= 4.5		